

CURVE

Los paneles flotantes **CURVE** están hechos de fibra de vidrio y son, por tanto, muy ligeros.

Pueden ser colocados en arreglos interesantes, tanto individualmente como en combinación. **CURVE 1** es un absorbente acústico clase A y puede ser recubierto con tela de color, lo cual ofrece aun mas posibilidades de diseño.

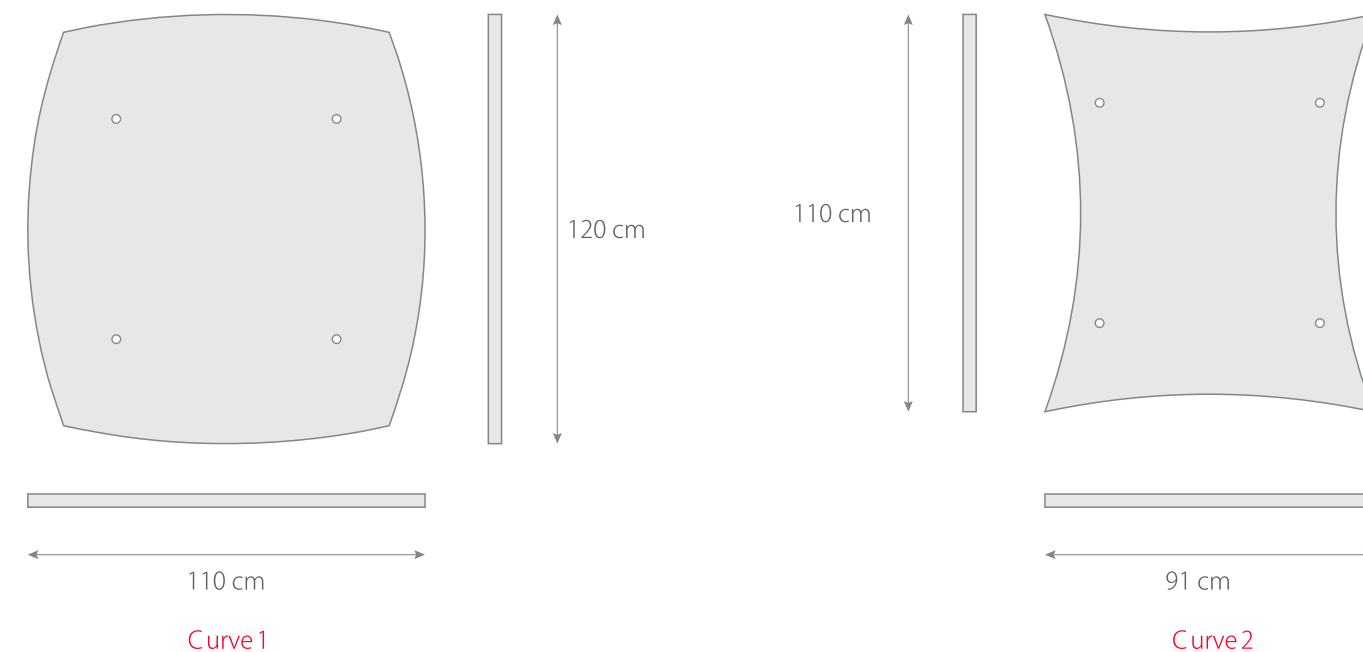

Material	Fibra de Vidrio cubierta con textil
Color	Blanco / Color
Peso aprox.	Curve 1: 5kg / Curve 2: 4kg
Abs. Acústica	$\alpha_w=1.00$ / NRC=0.95
Ancho	40 mm



ACABADO EN TELA

Selecta, Curve y Freestyle

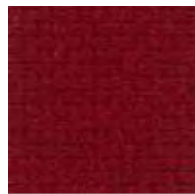

52826 | dark red



52827 | red



52828 | orange



52829 | dark brown

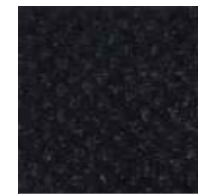

52830 | black

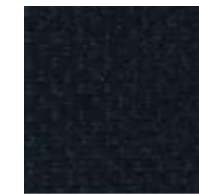

52831 | dark grey

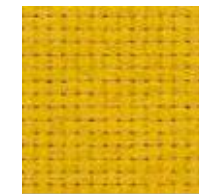

52832 | yellow

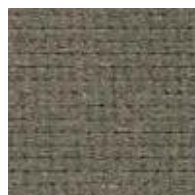

52833 | green-grey

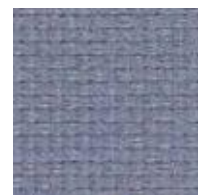

52834 | light grey

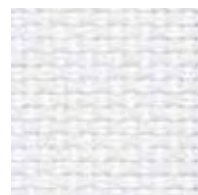

52835 | white

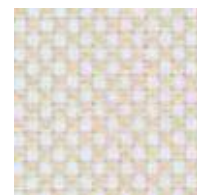

52836 | light beige

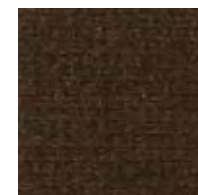

52837 | medium brown

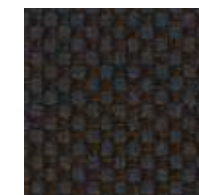

52838 | mottled brown



52839 | grey

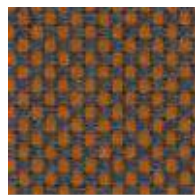

52840 | mottled orange



52841 | petrol

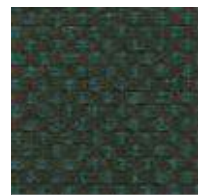

52842 | mottled green



52843 | blue



52844 | midnight blue



52845 | violet



52844 | stone grey



55245 | olive green

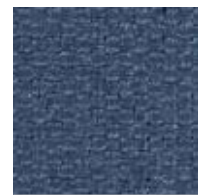

55246 | light blue



55247 | mint green



55248 | dark green



55249 | grey-blue



55250 | light yellow