

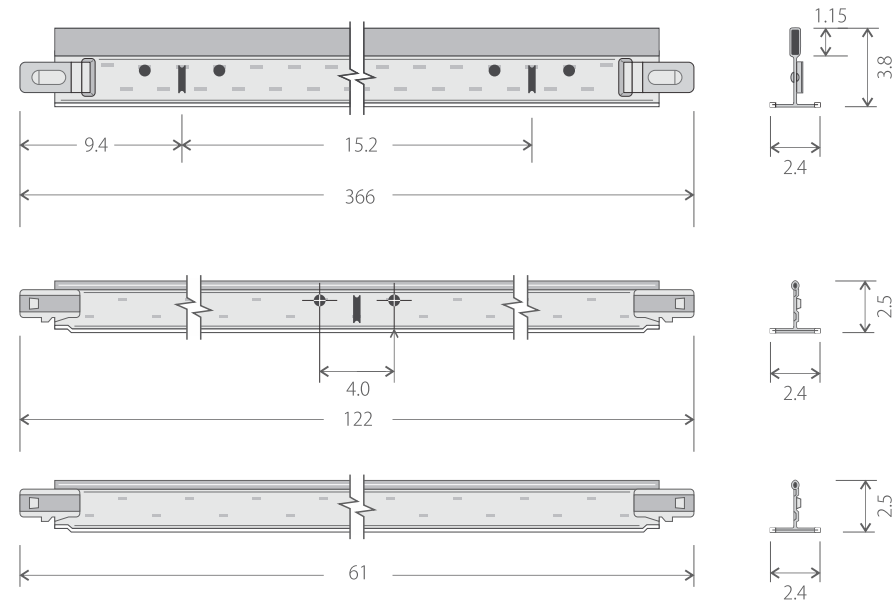

SISTEMA NEW DECO S3, S3a











Clase  A2-S1, d0 (EN13501-1)

Material  Acero Galvanizado

Color  Blanco

| Contenido | Tee Principal | 2.4 x 3.8 x 366 cm | 25 piezas/caja |
|-----------|-------------------|--------------------|----------------|
| | Tee Sec. (122 cm) | 2.4 x 2.5 x 122 cm | 50 piezas/caja |
| | Tee Sec. (61 cm) | 2.4 x 2.5 x 61 cm | 75 piezas/caja |
| | Ángulo Perimetral | 2.4 x 1.9 x 305 cm | 40 piezas/caja |

| Bordes |  |  |  |  |  |  |  |  | | | | | |
|-------------|---|---|---|---|---|---|---|---|----------|-------------|---------|--------|-------|
| Texturas | Finetta | Brillante | Sinf. Black | Sinf. Grey | Sanitas | Brillante | Cosmos | Sandila m. | Sinfonia | New Sandila | Finetta | Futura | Tecta |
| 61 x 61 cm | ■ | ■ | ■ | ■ | ■ | ■ | ■ | ■ | ■ | ■ | ■ | ■ | ■ |
| 122 x 61 cm | ■ | ■ | ■ | ■ | ■ | ■ | ■ | ■ | ■ | ■ | ■ | ■ | ■ |

*Absorción Acústica y R. Sonora calculadas con un pleno de 200 mm

SISTEMA NEW DECO S15, S15a

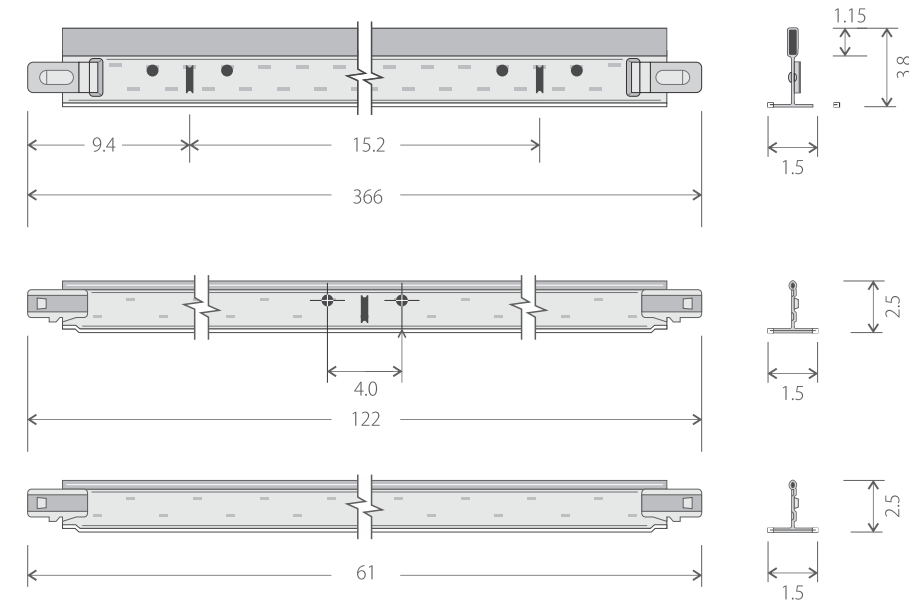









Clase  A2-S1, d0 (EN13501-1)

Material  Acero Galvanizado

Color  Blanco

| Contenido | Tee Principal | 1.5 x 3.8 x 366 cm | 25 piezas/caja |
|-----------|-------------------|--------------------|----------------|
| | Tee Sec. (122 cm) | 1.5 x 2.5 x 122 cm | 50 piezas/caja |
| | Tee Sec. (61 cm) | 1.5 x 2.5 x 61 cm | 75 piezas/caja |
| | Ángulo Perimetral | 1.5 x 1.9 x 305 cm | 40 piezas/caja |

| Bordes |  |  |  |  |  |  |  |  |
|-------------|---|---|---|---|---|---|---|---|
| Texturas | Brillante | Sinf. Black | Sinf. Grey | Sanitas | Cosmos | Sinfonia | | |
| 61 x 61 cm | ■ | ■ | ■ | ■ | ■ | ■ | | |
| 122 x 61 cm | ■ | ■ | ■ | ■ | ■ | ■ | | |